



**BIJUR DELIMON**  
INTERNATIONAL



**FARVAL<sup>®</sup>**  
**DUALINE<sup>™</sup>**  
**SYSTEMS**

- + Ideally suited for heavy industry
- + Continuous duty operation
- + Over 80 years of excellence

## Contents

<b>Introduction</b> .....	<b>3</b>
<b>Dualine Systems</b> .....	<b>4</b>
Multiple Valve Manifold and Grease Gun.....	4
Motor Driven Piston Pump System.....	4
Air Powered System .....	5
Manual Lubricator System .....	5
<b>Dualine Valves</b> .....	<b>6</b>
DD & DM Valves .....	6
DDM & SDM Modular Valves .....	8
Lube Point Monitor .....	10
<b>Lubricators</b> .....	<b>11</b>
DA Series Manual Lubricators.....	11
Air-operated Barrel Pumps.....	12
<b>Reversing Valves</b> .....	<b>14</b>
FR20.....	14
DR4-5.....	14
SA-V.....	15
<b>Central Stations</b> .....	<b>16</b>
DPG.....	16
CS2000 .....	16
DC36 .....	16
DC41 & DC42 .....	16
BM-B & BS-B.....	18
<b>Controllers</b> .....	<b>20</b>
SC400 .....	20
SS2200 .....	20
<b>Spray Systems</b> .....	<b>22</b>

INSURES LUBRICATION  
OF EVERY BEARING  
AND SLIDE • PREVENTS  
OVER AND UNDER  
LUBRICATION • SAVES  
LUBRICATION TIME •  
ELIMINATES LUBRICANT  
CONTAMINATION •  
PREVENTS PERSONAL  
INJURY HAZARDS •  
PROMOTES CONTINUOUS  
HIGH SPEED MACHINE  
OPERATION • REDUCES  
REPAIRS AND  
DOWNTIME • PROLONGS  
MACHINE LIFE •  
INCREASES  
PRODUCTION OUTPUT •  
REDUCES  
OPERATING COST

# Introduction

Dualine lubricating systems are found in virtually every industry in which continuous duty operation is required. From steel production to pulp and paper, from mining equipment to machine tools, automatic application of the lubricant provides significant benefits to the equipment user. There are several components that are used in designing a Dualine system:

- + Valves
- + Lubricators
- + Reversing Valves
- + Central Stations
- + Controllers
- + Spray Systems

## **Valves**

Measuring valves are the heart of Dualine lubrication systems. They are mounted close to the lubrication points and are hydraulically operated by pressure from the first and then the second of the two supply lines. On each pressurization cycle, they indirectly discharge fixed volumes of lubricant to the bearing or lubrication point.

## **Lubricators**

Manual, electric and pneumatic lubricators store and pump lubricant to Dualine valves throughout the system.

## **Reversing Valves**

These valves change the flow and direction of pressure, which causes divider valves in the system to cycle.

## **Central Stations**

Central stations include lubricator, cycle switch and reversing valve. Some versions are mounted on a plate for easier installation.

## **Controllers**

Programmable controllers give you access to key system functions, such as system on and off, and can control what happens when there is a problem in the system.

## **Spray Systems**

Used to lubricate large gears and pinion sets.

## **Advantages of Dualine Systems**

- + They are economical for a system having more than 20 bearing points.
- + Lubrication points can be added easily without redesigning the total system.
- + A blockage between main line and bearing will not shut the system down; remaining bearings will continue to be lubricated.
- + There are positive lubrication indicators for each bearing point.
- + They have the ability to positively displace a broad range of lubricants from light oil to grade 2 grease.
- + Lubrication discharge volume at each bearing is fully adjustable even after start-up.

# Dualine Systems

There are several various types of Dualine systems that can be designed using Bijur Delimon components featured in this brochure. Flexibility is a key part of the Bijur Delimon product family. The following represent typical system layouts.

## Motor Driven Piston Pump System

One of the most popular Dualine systems features Dualine valves, a central station (pump, cycle switch and reversing valve) and a controller.

### Relevant products include:

- + DD Valves, DM Valves or DDM/SDM Modular Valves (pages 6-9)
- + Central Stations (pages 16-19)
- + Controllers (pages 20-21)

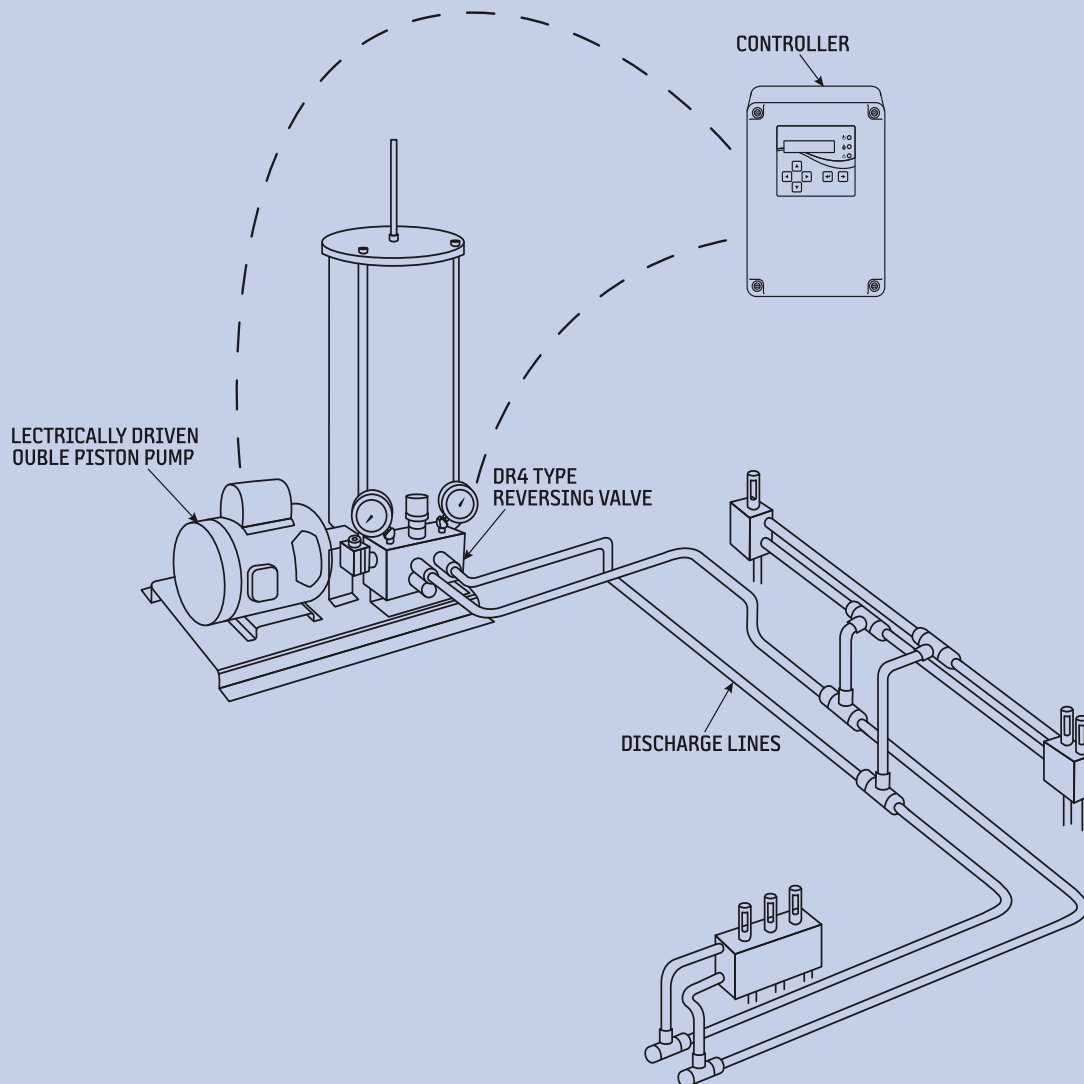

## Air Powered System

Another popular Dualine system utilizes an air-operated barrel pump providing lubricant to Dualine valves in the system. A reversing valve with a pressure gauge is utilized to reverse the lubrication flow in the system. A controller is also used to monitor system functionality. (See a variation of this system layout, *Spray Systems*, on pages 22-23.)

### Relevant products include:

- + DD Valves, DM Valves or DDM/SDM Modular Valves (pages 6-9)
- + Air Operated Barrel Pump (page 12-13)
- + Air Control Panel (see components on page 13)
- + Reversing Valve (pages 14-15)
- + Controllers (pages 20-21)

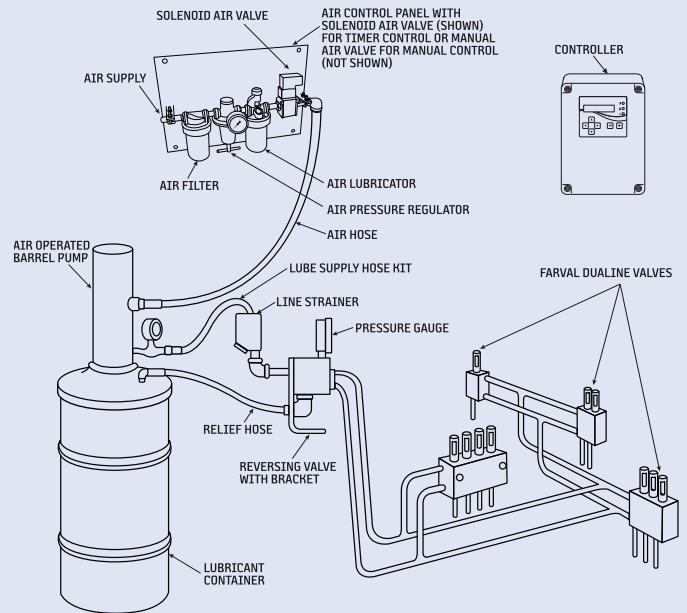

## Manual Lubricator System

Bijur Delimon has a complete line of manual lubricators that can be affixed to DD, DM or DDM/SDM Dualine valves. The lubricators have a built-in reversing valve so that pressure can be applied and released on each handle stroke.

### Relevant products include:

- + DD Valves, DM Valves or DDM/SDM Modular Valves (pages 6-9)
- + Manual Lubricators (page 11)

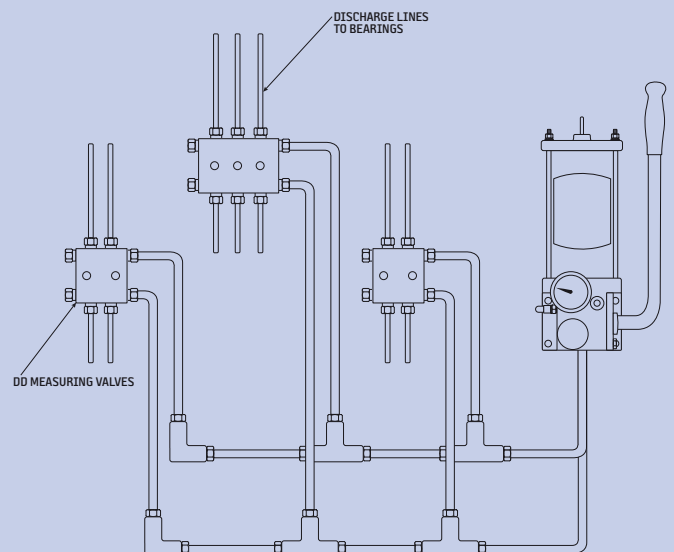



# Dualine Valves

## DD & DM Valves

Dualine DD and DM lubricating valves are completely hydraulic in operation and will deliver either oil or grease. They are also fully and individually adjustable in regard to discharge quantity and are equipped with operational indicators. Each DD valve serves two bearings; however, by a simple method of cross-porting, it will serve one. Therefore, a four valve block, as an example, can actually serve anywhere between four and eight bearings. DM series valves always have one discharge port per valve section located on the bottom of the valve. DD and DM valves can be supplied in several basic discharge capacities and are available in blocks consisting of one, two, three or four valves.

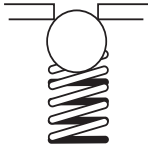
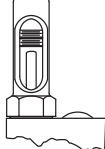
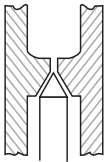
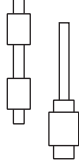
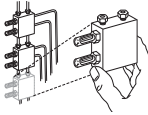
### Benefits

<p>No springs or check valves.</p> 	<p>Positive indication at every bearing.</p> 
<p>No small ports.</p> 	<p>Has only two moving parts.</p> 
<p>No system redesign when adding or subtracting points.</p> 	<p>Individually adjustable.</p> 



### Prox Switch Kits

Description	Part #
DM60 series	37291
DD50 series	37290

*Note: Need one kit for each indicator pin. See datasheet 35965 for additional information.*

See Datasheet #35513 for additional information on DD/DM valves.

### DD Valves

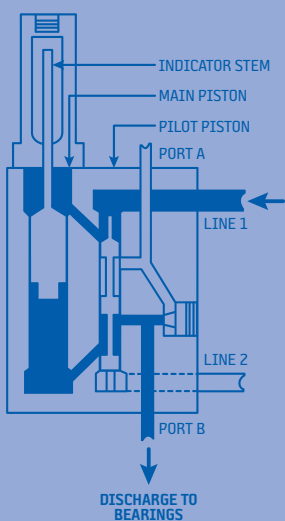

### DM Valves

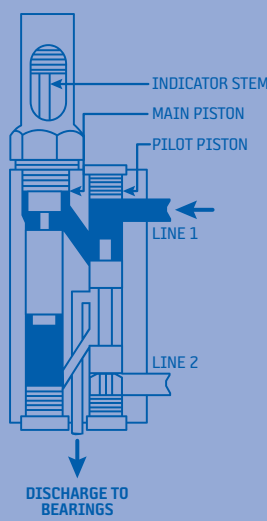

### How it Works

Pressurized lubricant entering the valve forces the pilot piston down, allowing pressure to be applied to top of the main piston. The main piston begins to move down under pressure, forcing lubricant from its chamber, past the lower land of the pilot piston and out the discharge line to the bearing. When pressure in the supply line is reversed, lubricant then enters valve and forces the pilot piston up, allowing pressure to be applied to bottom of main piston, which begins to move up, forcing lubricant from its chamber, past the upper land of the pilot piston and out the second discharge line to the bearing.

## Valve Output

Model	Discharge per piston stroke		Discharge change per adj. screw revolution	Total adj. range
	Minimum	Maximum		
DD-2X	0.09cc (0.006 cu. in.)	0.59cc (0.036 cu. in.)	0.03cc (0.002 cu. in.)	0.45" (11mm)
DD-5X	0.18cc (0.011 cu. in.)	4.74cc (0.289 cu. in.)	0.18cc (0.011 cu. in.)	1.21" (30mm)
DM-3X	0.19cc (0.012 cu. in.)	1.18cc (0.072 cu. in.)	0.08cc (0.005 cu. in.)	0.56" (14mm)
DM-4X	0.59cc (0.036 cu. in.)	2.21cc (0.135 cu. in.)	0.11cc (0.007 cu. in.)	0.69" (17mm)
DM-5X	1.23cc (0.075 cu. in.)	5.02cc (0.306 cu. in.)	0.16cc (0.010 cu. in.)	1.12" (28mm)
DM-6X	2.95cc (0.180 cu. in.)	13.11cc (0.800 cu. in.)	0.64cc (0.039 cu. in.)	0.97" (24mm)

Note: All DD & DM valves are rated to 3500 psi (240 bar) max.

## How to Order

Name	Lube points (#)	Basic valve without connectors	Basic valve with U-81-XX connectors	Basic valve without indicator tower for harsh environments
DD Valve	2	DD22-250	DD22-250T <sup>1</sup>	---
	4	DD24-250	DD24-250T <sup>1</sup>	---
	6	DD26-250	DD26-250T <sup>1</sup>	---
	8	DD28-250	DD28-250T <sup>1</sup>	---
	2	DD52-250	DD52-250T <sup>2</sup>	DD52250206 <sup>4</sup>
	4	DD54-250	DD54-250T <sup>2</sup>	DD54250206 <sup>4</sup>
	6	DD56-250	DD56-250T <sup>2</sup>	DD56250206 <sup>4</sup>
	8	DD58-250	DD58-250T <sup>2</sup>	DD58250206 <sup>4</sup>
	10	DD510-250	DD510-250T <sup>2</sup>	---
	12	DD512-250	DD512-250T <sup>2</sup>	---
	12	DD512C-250 (BSPP)	---	---
	DM Valve	1	DM31-100	DM31-100T <sup>2</sup>
2		DM32-100	DM32-100T <sup>2</sup>	---
3		DM33-100	DM33-100T <sup>2</sup>	---
4		DM34-100	DM34-100T <sup>2</sup>	---
1		DM41-100	DM41-100T <sup>2</sup>	---
2		DM42-100	DM42-100T <sup>2</sup>	---
3		DM43-100	DM43-100T <sup>2</sup>	---
4		DM44-100	DM44-100T <sup>2</sup>	---
1		DM51-100	DM51-100T <sup>2</sup>	---
2		DM52-100	DM52-100T <sup>2</sup>	---
3		DM53-100	DM53-100T <sup>2</sup>	---
4		DM54-100	DM54-100T <sup>2</sup>	---
1		DM61-100A	DM61-100AT <sup>2</sup>	---
2		DM62-100A	DM62-100AT <sup>2</sup>	---
1		DM62-101A <sup>3</sup>	DM62-101AT <sup>2</sup>	---

<sup>1</sup> Supply 1/4" tube; discharge 3/16" tube <sup>2</sup> Supply 3/8" tube; discharge 1/4" tube <sup>3</sup> Discharge supply 2 x DM61  
<sup>4</sup> Output volume is not adjustable and fixed at maximum

When ordering, specify by name, lube points and part number, e.g. DM Valve without connectors, 3 lube points, Part #DM33-100.

## Typical Layout

### DD Valve

A typical four valve DD block with eight discharge ports. The valves can easily be converted from dual to single discharge by a cross porting kit. Valve can be reconverted later to dual discharge.

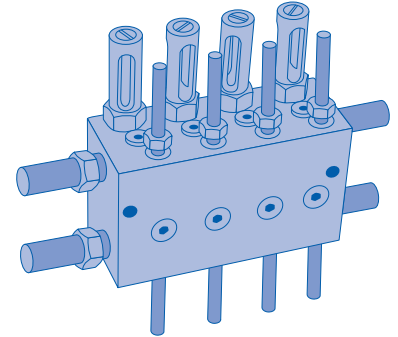

1. Brass indicator housing standard
2. Solid copper crush washers for superior sealing
3. Viton seals standard 350°F (163°C)
4. Easy ID if using single or dual outlet plugs
5. Stainless steel indicator pins standard
6. NPT or BSP outlets available will accept all standard fittings and U81 fittings
7. 10,000 psi rated Koenig plugs used to seal machining ports
8. Solid pin connection to main piston
9. Available in 1-12 lubrication outlets

### DM Valve

A typical one valve DM block. Valve has a discharge port on the bottom. A four valve block would have four discharge ports.

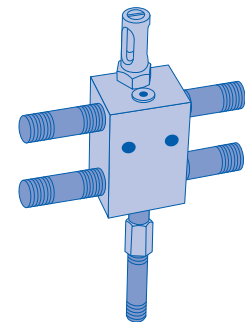

1. Supply ports from pump
2. Adjustment screw (varies valve output)
3. Indicator stem (shows that valve is operating)
4. Check valve (required in discharge port of some oil systems)

## DDM & SDM Modular Valves

Dualine DDM and SDM lubricating valves have many advantages over traditional line mounted models. All working parts are in the module and these modules are fitted to base manifolds which are permanently fitted to the centralized lubrication system. The double discharge module DDM feeds two lubrication points on alternative system cycles while the single discharge module SDM feeds a single lubrication point on each cycle.

A mixture of double and single discharge modules can be fitted to each manifold either for assembly to serve an odd number of bearings or to give a greater lubricant quantity to selected points. Three sizes of modules can be supplied to cover a wide range of metered application volumes.

### Benefits

- + Modules can be individually adjusted within its capacity to suit bearing requirements.
- + A malfunctioning module can be changed in seconds, reducing maintenance time and costs.
- + Positive hydraulic operation – Within design limitations, these valve assemblies can be mounted long distances from the central pumping station.
- + Visual indicator showing operation of each module.
- + Body protected by corrosion resistant electrophoretic paint.

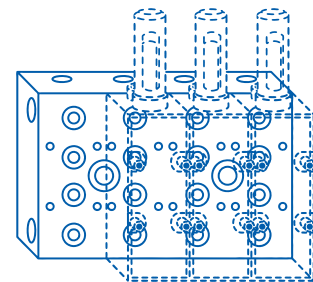

### Technical Data

<b>Maximum Supply Pressure</b>	5075 psi (350 bar)		
<b>Temperature Range</b>	-5°F to 248°F (-20°C to 120°C)		
	-5°F to 194°F (-20°C to 90°C)		
<b>Lubricant</b>	Oil or grease (NLGI grade 3 max)		
<b>Materials</b>	<b>Body</b>	Steel - Electrophoretically painted	
	<b>Pistons</b>	Hardened steel	
	<b>Packing gland</b>	DDM1/SDM1, DDM5/SDM5 - Brass	
		DDM15/SDM15 - Steel	
	<b>Seals</b>	DDM1/SDM1; DDM5/SDM5 - Viton	
		DDM15/SDM15 - Nitrile	
	<b>Indicator stem</b>	Stainless steel	
<b>Discharge per Outlet per Double Cycle</b>	<b>Valve size</b>	<b>Maximum</b>	<b>Minimum</b>
	DDM1	1.0cc (0.06 cu. in.)	0.1cc (0.006 cu. in.)
	SDM1	2.0cc (0.12 cu. in.)	0.2cc (0.012 cu. in.)
	DDM5	5.0cc (0.31 cu. in.)	0.5cc (0.031 cu. in.)
	SDM5	10.0cc (0.61 cu. in.)	1.0cc (0.061 cu. in.)
	DDM15	15.0cc (0.92 cu. in.)	3.0cc (0.183 cu. in.)
	SDM15	30.0cc (1.83 cu. in.)	6.0cc (0.366 cu. in.)



## Manifolds

Three ranges of base manifolds suitable for mounting the modular measuring valves, DDM1, SDM1, DDM5, SDM5, DDM15 and SDM15.

### Benefits

- + Manifolds can be permanently fixed to the lubrication system pipe work before valves are fitted, reducing possibility of contamination during installation period.
- + O-ring recesses are fitted into the top of the adapter so that the fitter can observe the condition of O-rings when he is fitting the module.
- + Manifolds are available in various sizes for multiple module configurations.

### How to Order

DDM/SDM modular valves and manifolds feature a smart part number ordering system, where you can tailor the modular valves and manifold to meet your needs.

#### For modular valves:

First, choose the module type, valve size and visual indicator you need. Then, put the numbers into the corresponding squares in the easy-to-use grid.

Example: To order a DDM1 modular valve with double indicator and a visual indicator with cover, you would use Part #DDM11A0100.

#### For manifolds:

First, choose the manifold type and number of outlets. Then, put the numbers into the corresponding squares in the easy-to-use grid.

Example: To order a MA1 manifold with 8 outlets, you would use Part #MA108A00.

You now have the customized part numbers for both your modular valve and manifold.

#### For mounting kits:

When ordering mounting kits, specify by description, name and part number listed in the table, e.g. DDM1 Mounting Kit, Part #DDM500001E.

#### Modular Valves

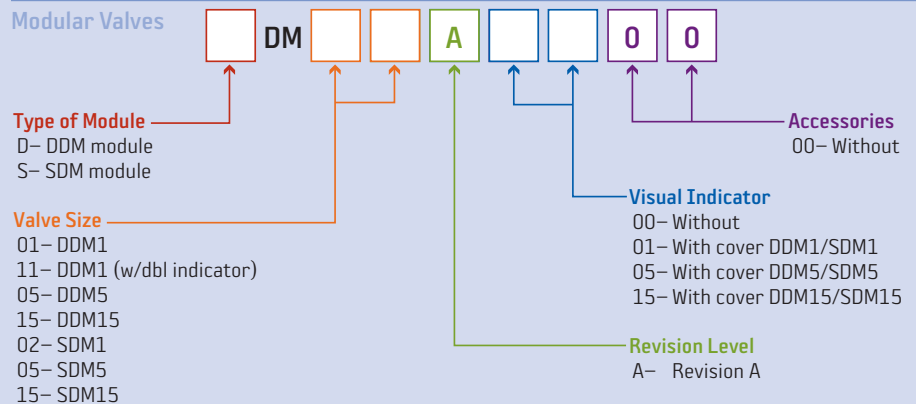

#### Manifolds

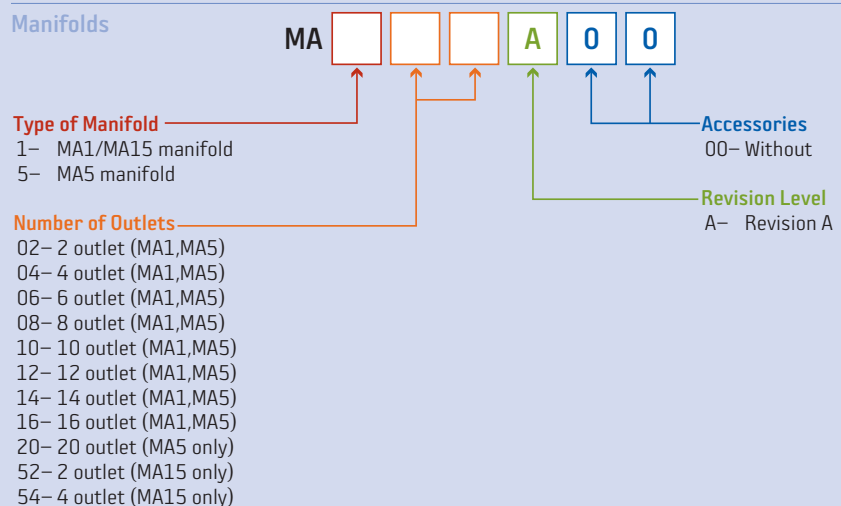

#### Mounting Kits

Name	Type	Description	Part #
Mounting Kits	Valve <sup>1</sup>	DDM1/SDM1	DDM500001E
		DDM5/SDM5	DDM500050
		DDM15/SDM15	DDM150050
	Manifold <sup>2</sup>	MA1	MA1022204E
		MA5/MA15	MA515022003E

<sup>1</sup> One kit is required per valve. Each kit includes 4 screws and 4 O-rings.

<sup>2</sup> One kit is required per manifold. Each kit includes 2 screws and plugs.

# Lube Point Monitor

## General

The 55105 Lube Point Monitor is an accurate oval gear mechanism that incorporates two magnets into one of the nylon oval gears. The body incorporates a reed switch which senses the magnet passing. Lubricant entering the 55105 causes the gears to rotate. Each pulse equates to an approximate displacement of 0.040 cu. in. (.65cc). The monitoring of the 55105 is done with any PLC. The feedback from the 55105 will assure that lubricant has reached the inlet of critical lubrication points.

## Application

The 55105 Lube Point Monitor is intended to be mounted at or near the lubrication point inlet. It can be used with any type of grease or oil system (Dualine/Progressive/PDI). Due to the nature of the internals, proper filtration is required to keep contaminants out of the monitor body.

## Technical Data

Flow	0-2500cc/min.	
Maximum Pressure	10153 psi (700 bar)	
Accuracy	±3%	
Vibrations	20 g (10-20000 Hz)	
Life Time	10 <sup>9</sup> pulses	
Temperature	-4°F to 158°F (-20°C to 70°C)	
Connections	1/8" NPT	
Material	Aluminum	
Weight	0.186 kg	
Lubricant	ISO VG 32 Oil to NLGI Grade 2 Grease	
IP Enclosure Rating	IP-67	
Connection	4-pole M12 x 1 (male)	
Switch Rating	Maximum Voltage	0-24 VDC
	Maximum Current	0.20 amp

## Wiring

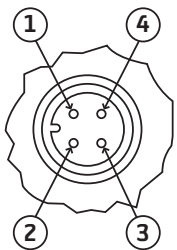

PIN #	Description	Wire Color
1	Common	Brown
4	Signal	Black



See Datasheet #35978 for additional information.

# Lubricators

## DA Series Manual Lubricators

To support the successful operation of Dualine measuring valves and to ensure their performance, Bijur Delimon has designed equally rugged pumping units which provide a dependable high-pressure source of lubricant supply.

For bearings that require an application of lubricant once or twice per shift, a manually-operated central pumping unit is used. These units consist of a double-acting piston pump, reciprocated by a hand lever through a rack-and-gear segment. A quick-fill connection provides a convenient means of filling the reservoir, and an inlet filter screen gives added protection against the entry of dirt. They may be located on the machine being lubricated or at any convenient point nearby. When the lubricant is oil, a float with oil level rod replaces the grease follower plate. Three sizes of reservoirs provide a supply of lubricant adequate for the number of bearings being lubricated.

### Technical Data

<b>Reservoir Capacity</b>	Grease	2 kg (4.5 lb), 4 kg (8.25 lb), 6 kg (12.5 lb)
	Oil	2.4 liter (2.5 qt)
<b>Discharge</b>		7.4cc (0.45 cu. in.)
<b>Viscosity Range</b>	Grease	NLGI grade 000-2
	Oil	ISO-32 and greater
<b>Internal Filter</b>		Available on all models
<b>Pressure Gauge</b>		Available on all models
<b>Cycle Indicator</b>		Available on some models
<b>Max Pressure</b>		3500 psi (241 bar)



See Datasheet #35495 for additional information.

### How To Order

When ordering, specify by name, lubricant, reservoir capacity and part number, e.g. DA manual lubricator, grease, 12.5 lb reservoir, **Part #DA6101AC**.

Name	Lubricant	Reservoir Capacity	Part #
DA Manual Lubricator	Grease	2 kg (4.5 lb)	DA4101AC
		4 kg (8.25 lb)	DA5101AC
		6 kg (12.5 lb)	DA6101AC
	Oil	2.4 liter (2.5 qt)	DA4101BC

## Air-operated Barrel Pumps

Air-operated barrel pumps are used where medium to heavy duty service conditions exist and rapid build-up of lubricating system pressure is desired in air-operated central stations.

### Notes

- + Built-in air exhaust muffler is standard on all pumps.
- + Grease pumps incorporate an inlet strainer.
- + Bung adapter is included with all pumps.
- + Part #9035, #9120 and #9400 all include return tube (hose on #9035) to bottom of drum.
- + Part #9035 includes a drum cover and follower plate.
- + Part #9120 includes a drum cover.
- + See *Catalog #27539: Industrial Lubrication* for complete pump offering.



### Technical Data

	9035	9120	9400
<b>Max. Delivery*</b>	650cc (40 cu. in.)	650cc (40 cu. in.)	650cc (40 cu. in.)
<b>Air Inlet</b>	1/4" NPT	1/4" NPT	1/4" NPT
<b>Lube Outlet</b>	3/8" NPT	3/8" NPT	3/8" NPT
<b>Height</b>	24" (610mm)	36.5" (925mm)	44" (1120mm)
<b>Weight</b>	24 lb	27 lb	21 lb

\* Maximum delivery for grease pumps, free delivery with NLGI grade 2 grease @ 70°F (20°C) with 100 psi (7bar) air pressure.

### How to Order

When ordering, specify name, type, ratio, drum size and part number, e.g.

Air-operated Barrel Pump, Grease, 55:1 Ratio, 35lb Drum, Part #9035.

Name	Pump Type	Ratio	Drum Size	Part #
Air-operated Barrel Pump	Grease	55:1	35 lb	9035
			120 lb	9120
			400 lb	9400

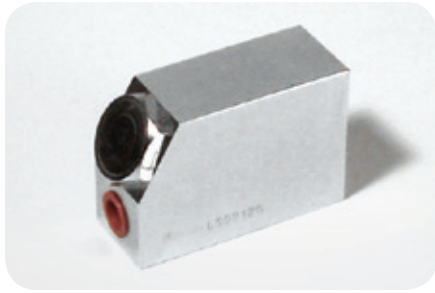

## Line Strainers

Line Strainers remove foreign particles from grease and oil lines in lubricating systems.

### How to Order

Line strainers feature a smart part number ordering system. First, choose the pipe tap size, dirty screen indicator, usage and micro switch option. Then, put the numbers into the corresponding squares in the easy-to-use grid. You now have the customized part numbers for your line strainer.

Example: To order a Line Strainer with 1/4" NPT, with dirty screen indicator and 25 micron screen, you would use Part #LS-02-203.

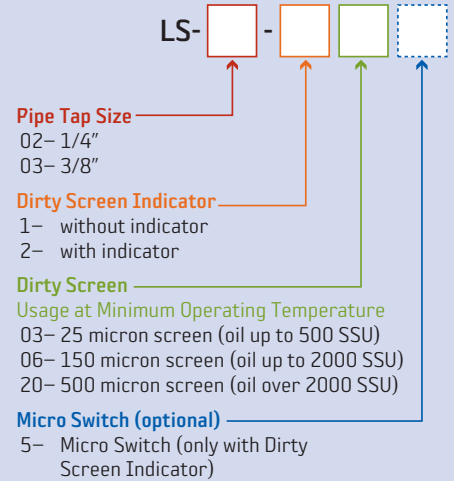

## Accessories

Name	Description	Part #
Steel follower plates	Follower for 35 lb pail	F962
	Follower for 120 lb drum	F964
	Follower for 400 lb drum	F966
Drum covers	Heavy duty cover for 35 lb pail	F1934
	Heavy duty cover for 120 lb drum	F1936
	Heavy duty cover for 400 lb drum	F1938
Low level switch kit*	Low level switch for 120 lb drum	LC10243
	Low level switch for 400 lb drum	LC11036
Air regulators and gauges	1/2" regulator (0-250 psi range) 2" (0-160 psi) pressure gauge	F976
	3/8" regulator (0-250 psi range) 2" (0-160 psi) pressure gauge	F973
Filters	1/2" filter	F978
	3/8" filter	F975
Lubricators	1/2" lubricator	F977
	3/8" lubricator	F974
Quick coupler and nipples	1/4" NPT(F) coupler	F930
	1/4" NPT(M) nipple	F931
	3/8" NPT(M) nipple	F941
	1/2" NPT(F) coupler	F940
Filter/Regulator/Lubricator Combination	1/2" filter, 1/2" regulator (0-250 psi), 2" gauge (0-160 psi) and lubricator	F985
	3/8" filter, 3/8" regulator (0-250 psi), 2" gauge (0-160 psi) and lubricator	F984
Line strainers screens	25 micron screen (Oil only up to 500 SSU)	LS-02-05-103
	150 micron screen (Oil only up to 2000 SSU)	LS-02-05-106
	500 micron screen (Oil over 2000 SSU & all grease)	LS-02-05-120
Drum Heater Insulated Blankets	Fits 120 lb. drum (15 gal/57 liter)	37506
	Fits 400 lb. drum (55 gal/208 liter)	55286

\* Requires cover and follower plate, customer/user to provide 15/16" hole in cover, can be used with any style pump.



Drum Cover

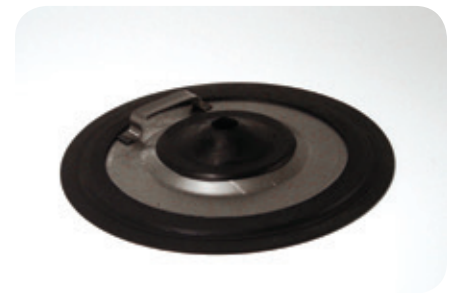

Follower



Filter/Regulator/Lubricator Combination

# Reversing Valves

In a Dualine lubricating system, the reversing valve directs pump flow to one of the two main supply lines while the second supply line is in relief to the pump reservoir. At the completion of each half lubrication cycle, the reversing valve redirects the pump and relief flow. Thus, on each succeeding half lubrication cycle, pressure and relief flow are alternated in the two main supply lines. This action causes the measuring valves to stroke and discharge lubricant to their respective bearings. In an automatic system, the reversing valve also controls maximum system pressure and pump shut down.

## FR20

These reversing valves operate in conjunction with pressure switches. They control end-of-line systems (DC41 central stations and air powered systems).

### Technical Data

Maximum Flow Rate	12 gpm (Oil)
Maximum Allowable Pressure (Non-Shock)	5000 psi (3000 psi @ relief port)
Spool Configuration	2 position, 4 way
Solenoid	Push type epoxy covered coil
Inrush Current	5.5 amp
Holding Current	1.1 amp
Seals	Buna "N" rubber



FR20

See Datasheet #35585 for additional information.

## DR4-5

These reversing valves are activated by system pressure and are adjustable between 500 and 3500 psi. They control non-return and return systems using CS2000, DC36 and DC42 central stations. They are also used with air barrel pumps for spray and medium and large dualine systems.

### Technical Data

Lubricant	SAE 10 oil to NLGI grade 2 grease	
Materials	Housing	Zinc with yellow chromate
	Piston	Low carbon steel
Pressure Range	500-3500 psi	
Seals	Buna "N" rubber	

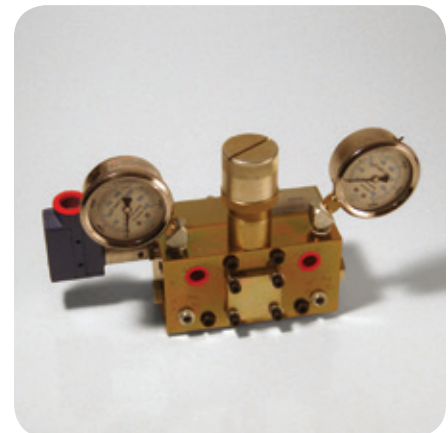

DR4-5

See Datasheet #DL1200 for additional information.

## SA-V

This reversing valve is designed for use in hydraulic Dualine systems. It can be used as a 4/2 or a 3/2 valve and is driven by a direct current geared motor.

### Technical Data

Maximum Operating Pressure	5800 psi (400 bar)
Temperature Range	-4°F to 176°F (-20°C to 80°C)
Maximum Power Consumption	42 W
IP Enclosure Rating	IP-65

### SG-A Switching Device

The switching device SG-A must be used in conjunction with the SA-V reversing valve. It is used as a differential pressure switch. When the differential pressure is 50 bar and/or 100 bar, the SA-V releases a pulse for the reversion of the directional control valve or for the monitoring of the system.



SA-V



SG-A Switching Device

### How to Order

When ordering, specify name, description and part number, e.g. DR4-5 Reversing Valve with limit switch, pressure gauges and mounting bracket, **Part #DR459**.

Name	Description	Part #
FR20 <sup>1&amp;5</sup>	115 VAC (50-60 Hz), Not supplied with mounting kit.	37149115N1
	115 VAC (50-60 Hz), Supplied on DC41 w/ mounting brackets and hardware.	37149115N2
	230 VAC (50-60 Hz), Not supplied with mounting kit.	37149230N1
	24 VDC, Not supplied with mounting kit.	3714924N1
DR4-5	Basic valve.	DR45
	Valve with limit switch, pressure gauges and mounting bracket.	DR459
	Valve with limit switch, pressure gauges and line connecting hardware.	DR45K
	Valve with limit switch, pressure gauges, mounting brackets and line strainer.	DR460A <sup>3</sup>
	Valve with limit switch, pressure gauges, mounting brackets and line strainer.	DR460B <sup>4</sup>
SA-V <sup>2</sup>	110-127 VAC and 200-240 VAC	SAV11A00
	24 VDC	SAV24A00
SG-A	50 Bar	SGA05A00
	100 Bar	SGA10A00

<sup>1</sup> Refer to Datasheet #35585: FR20 Reversing Valve, for all available versions.

<sup>2</sup> SGA-A switching device is required for SA-V.

<sup>3</sup> Grease only

<sup>4</sup> Oil only

<sup>5</sup> Operates in conjunction with pressure switches(2), p.n. U620D1

# Central Stations

Central stations store, control and supply the lubricant to Dualine systems. The major components are a motor, pump, reservoir and reversing valve.

Central stations are available in 7 series: DPG, CS2000, DC36, DC41, DC42, BM-B and BS-B. Each series offers a different capability in terms of type and quantity of lubricant which can be handled and type of system that can be served. Each is available with motor and reservoir options and optional high or low level switches as indicated.

## DPG

The DPG Pneumatic Lubricator is an air-operated reciprocating lubricator that discharges a fixed amount of lubricant into systems during a lubrication cycle. It includes a transparent reservoir with low level and spring loaded follower, reversing valve, grease strainer, FRL, air solenoid valve and a filler fitting for refilling of reservoir.

## CS2000

CS2000 stations store, control, and supply the lubricant to systems. Depending on reservoir size, they can be used in systems that service anything from small machine tools to large machinery in steel mills, or from small to large off road machinery such as power drills, power shovel, and drag lines.

Standard items on these stations include a switch arrangement for automatic level warning systems, visual level indication, an adjustable relief valve and an electrically driven pump. A variety of reservoir types and sizes and a high level warning switch are offered. Kits are also available for mounting controls and NEMA 4 applications.

## DC36

DC36 stations store, control, and supply lubricant to systems. The lubricant must be oil with a viscosity of not greater than 1900 SSU at 100°F. DC36 stations can be used in systems that service equipment requiring oil lubrication such as machine tools and transfer equipment.

Standard items on these stations include a low level warning switch for connection to lights or horns, oil level sight gauge, a 30 mesh oil filter and an air breather cap in the oil filler port.

## DC41 & DC42

DC41 and DC42 stations can supply either oil or grease to such installations as bar mills, billet mills, blast furnaces, and sintering machines. The two systems differ in the way they alternately pressurize and relieve (reverse) the two supply lines as well as in the way they control maximum system pressure and end the lubrication cycle. On DC41 systems, pressure is controlled by a pressure switch (one is installed in each line) that actuates the reversing valve (FR20) and stops the pump motor when system pressure rises to its setting. On DC42 systems, pressure is controlled by the reversing valve (DR45). The valve opens a micro switch, which stops the pump motor when system pressure rises to its setting. Timer controls for each type tailored to meet its specific requirements are available.



*DPG Lubricator*



*CS2000 Station*



*DC36 Station*



*DC41 Station*



## Technical Data

	DPG	CS2000	DC36	DC41	DC42
Pump Output	6.0 in <sup>3</sup> /min	6.0 in <sup>3</sup> /min	34.6 in <sup>3</sup> /min	33.6 in <sup>3</sup> /min	33.6 in <sup>3</sup> /min
Pump Type	Air-reciprocating	Double Piston	Gear	Double Piston	Double Piston
Max. Work Pressure	3000 psi	2500 psi	1000 psi	2500 psi	2500 psi
Relief Pressure	N.A.	3000 psi	1500 psi	3000 psi	3000 psi
Gear Ratio-Std.	30:1 (air)	10:1	N.A.	10:1	10:1
Pump #	33457	DJ-2000	U-985-9W	DJ4-5	DJ4-5
Reversing Valve	DR45	DR4-5	DR4-5	FR20 (SOL type)	DR4-5
Rev. Press-Factory Setting	1500 psi	1500 psi	700 psi	N.A. <sup>2</sup>	1500 psi
Rev. Press-Range	1200-1500 psi	500-3500 psi	500-1000 psi	N.A. <sup>2</sup>	500-3500 psi
Motor	N.A.	Optional	Optional	Optional	Optional
Motor HP	N.A.	1/3	1/3	1	1
Motor Enclosure	N.A.	TEFC	TEFC	TEFC	TEFC
Motor Frame Size	N.A.	48	56	143/145T	143/145T
Low Level Switch	Yes	Yes	Yes	Optional	Optional
High Level Switch	No	Optional	Optional	Optional	Optional
Rev. Valve Limit Switch	Yes	Yes	Yes	No	Yes
Lubricant	Oil/Grease	Oil/Grease	Oil	Oil/Grease	Oil/Grease
System Type	Non-Return <sup>1</sup>	Non-Return <sup>1</sup>	Loop	EOL	Non-Return <sup>1</sup>

<sup>1</sup> Field Conversion for Loop Operation    <sup>2</sup> Controlled by end of line pressure switches (see Catalog #1800G: Fittings, Accessories, Regulators and Lubricators)

## How to Order

When ordering, specify by model, voltage, reservoir and part number, e.g. Central Station CS2000, 230/460 VAC (50/60 Hz), 10 lb steel reservoir, **Part #CS2212**.

For other available voltages consult Bijur Delimon customer service.

Model	Voltage	Reservoir	Level Switches		Part #	
			Low	High	With Motor	Without Motor
DPG	120 VAC (50/60 Hz)	10 lb Plastic (Grease)	X		39948	---
		5 Liter Plastic (Oil)	X		37629	
CS2000	Three Phase 230/460 VAC (50/60 Hz)	6 gallon steel	X		CS2206	---
			X	X	CS2207	---
		10 lb plastic	X		CS2210	CS2410*
			X	X	CS2211	---
		10 lb steel	X		CS2212	---
		24 lb steel	X		CS2224	CS2424*
			X	X	CS2225	CS2425*
	X	X	CS22101	CS24101*		
DC36	Three Phase 230/460 VAC (50/60 Hz)	30 gallon steel	X		DC36M-30B	DC36-30B
DC41	Three Phase 230/460 VAC (50/60 Hz)	100 lb steel	X	X	DC41M-31C	---
		200 lb steel			---	DC41-32A
			X	X	DC41M-32C	DC41-32C
DC42	Three Phase 230/460 VAC (50/60 Hz)	30 gallon steel	X	X	DC42M-33D	DC42-33D
		100 lb steel	X	X	DC42M-31C	---
					DC42M-32A	---
		200 lb steel	X	X	DC42M-32C	DC42-32C

\* Motor Mounting Kit is required for CS2000 without motor: 48 FR use Part #LC10705, 56 FR use Part #LC10706.

## BM-B & BS-B

In applications where electricity is available to power the lubricator, our BM-B and BS-B models are ideally suited to be the heart of a lubrication system. These pumps are robust for harsh and severe applications and their compact construction of high-grade steel gives them a long service life. They are ideally suited to service medium- and large-sized machinery. They can also be used for refilling and mobile greasing systems.

BM-B and BS-B lubricators do not ship with a reversing valve. See pages 14-15 for a selection of Bijur Delimon reversing valves. The lubricators are valveless, positive displacement pumps consisting of a series of pistons actuated in a controlled sequence by an eccentric cam. The motion develops a controlled suction and discharge action, producing a rugged, trouble-free lubricator.

A pressure relief valve is standard on both versions. This device can be adjusted to control operating pressure to the rest of the lubrication system. A grease agitator and wedge plate assembly are also standard on the BM-B and BS-B, working the reservoir grease and assisting in lubricator performance. An ultrasonic level switch and pressure gauge are available as optional accessories.

### Technical Data

<b>Maximum Working Pressure</b>	5800 psi (400 bar)		
<b>Grease</b>	NLGI grade 000-2		
<b>Other Greases and Oils (Includes synthetic types)</b>	Consult Bijur Delimon		
<b>Reservoir Capacity</b>	BM-B	8 liter (16.5 lb), 15 liter (31.5 lb) and 30 liter (63 lb)	
	BS-B	60 liter (126 lb), 100 liter (210 lb)	
<b>Discharge</b>	BM-B	2 & 4 liter/h, dependant upon driving speed	
	BS-B	7, 4 & 22 liter/h, dependant upon driving speed	
<b>Maximum Outputs, Nominal (Ref. motor sizes)</b>	BM-B	63 rpm	40cc/min. (2.44 cu. in./min.)
		125 rpm	80cc/min. (4.88 cu. in./min.)
	BS-B	80 rpm	120cc/min. (7.3 cu. in./min.)
		160 rpm	235cc/min. (14.3 cu. in./min.)
	250 rpm	365cc/min. (22.2 cu. in./min.)	
<b>Temperature Range (Ambient)</b>	-5°F to 176°F (-20°C to 80°C)		
<b>Built-in Pressure Relief Value</b>	0 to 5800 psi (0 to 40 bar)		



BM-B



BS-B

## How to Order

BM-B and BS-B Lubricators feature a smart part number ordering system, where you can tailor the lubricator to meet your needs. First, choose the gear motor, reservoir capacity and accessories you need. Then, put the numbers into the corresponding squares in the easy-to-use grid. You now have the customized part numbers for your lubricator.

Example: To order a BS-B Lubricator with a 2 hp (160 rpm) three phase flange mounted gear motor, 60 liter reservoir and a level switch, you would use Part #BSB01A030A01.

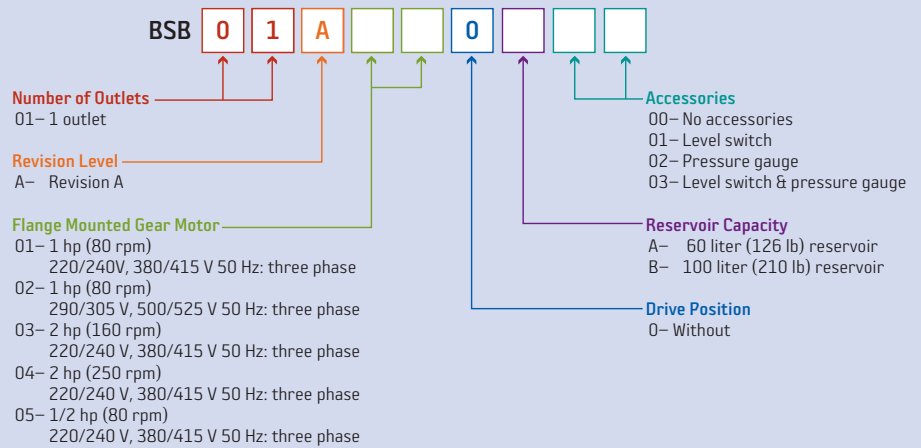
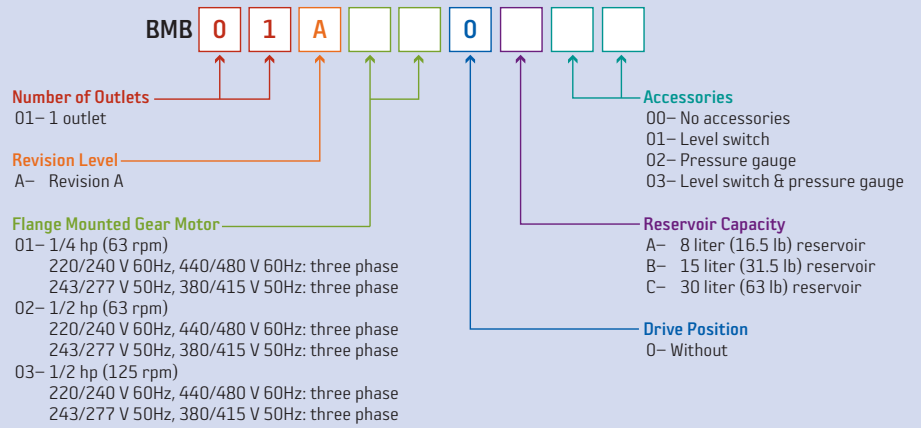

# Controllers

## SC400

The SC400 Multi-Function Controller/Monitor is designed to operate, control and monitor all types of Dualine systems, including those having an electric or hydraulic reversing valve. The unit is easily programmed by the customer via the controller's set up mode.

The SC400 also allows customers to operate a two zone system with a single control. The SC400 has the ability to operate a pump and two zone valves. Each zone operates independently. "Two zone" feature is not available for Dualine electric reversing valve systems or for systems that require "air purge" (afterblow).

The SC400 also incorporates an automatic fill feature. The SC400 activates a fill pump (as needed) to maintain proper fluid levels.

### Features

- + IP-56 Enclosure Rating, constructed of molded polyester fiberglass.
- + Chemical and temperature resistant and water tight to dripping and sprayed fluid.
- + Manual lubrication button.
- + Easy-to-use push button program review feature.
- + Automatic Fill Control: Capable of monitoring and controlling reservoir fluid level.
- + Four supported languages (English, French, Spanish, German).
- + Machine watchdog and cycle monitoring.
- + Pause (standby), jog (manual operation).
- + Critical Inputs accept PNP, NPN, or mechanical switches.
- + Accepts all BDI electric reversing valves and cycle/pressure/"end-of-line" switches.
- + CE Approved



See Datasheet #35979 for additional information.

## SS2200

The SS2200 is a microprocessor-based programmable controller designed to operate single line and Dualine central lubrication systems. The SS2200 is housed in a NEMA 4X polycarbonate enclosure with a transparent cover. Visible through the cover are LED indicators for Idle, Lube and Fault modes, and a three-digit numerical display used for programming and monitoring lubrication system operation.

### Features

- + Simple three key programming.
- + Controls both single line and dual line lubrication systems.
- + Operates electric or air driven pumps.
- + Time or machine cycle based operation.
- + Programmable for remote fault indication and emergency machine shutdown.
- + LED indicators and numerical displays monitor system operation.
- + EEPROM permanently stores programming without battery backup.



See Datasheet #24735 for additional information.

## Technical Data

	SC400	SS2200
Input Voltage	85 to 265 VAC, 50/60 Hz	115 VAC, 50/60 Hz
Current Consumption	80 mA at 115 VAC (less load) 40 mA at 230 VAC (less load)	---
Pump Output Rating	8 amp (85 to 265 VAC)	Pulsed or continuous, Form A, 115 VAC, 5 amp inrush, 2 amp continuous
Line A Output Rating	8 amp (90 to 250 VAC)	---
Line B Output Rating	8 amp (90 to 250 VAC)	---
Enclosure Rating	IP-56	NEMA 4X, polycarbonate
Ambient Temp. Range	14°F to 131°F (-10°C to 55°C)	20°F to 120°F (-7°C to 49°C)
Storage Temp. Range	-40°F to 185°F (-40°C to 85°C)	---
Vibration	2 g at resonant (3 axis)	1.5 g
Idle Time Range	1 second to 100 days	1-999 min, 1-999 hour, 1-999 or 10-9990 machine counts
Machine Cycle Counts	1 to 999,999 Counts (30 counts/second at 50% duty cycle)	---
Watchdog Timer	1 second to 60 minutes	---
Monitor Time	1 second to 24 hours	---
Timing Accuracy	0.01% (crystal controlled)	---
Cycle Counts On	1 to 999 counts	1 to 99 counts
Over Counts	0 to 9	---
Net Weight	5 lb	---
Length x Width x Height	12.3" x 9.2" x 5"	---
Permanent Memory	FLASH	EEPROM (no battery)
Fault Relay Contacts	5 amp	2 amp, 125 VAC

## How to Order

When ordering, specify by name, voltage and part number, e.g. SC400 Controller, 85-265 VAC, Part #SC400.

Name	Voltage	Part #
SC400 Controller	85-265 VAC	SC400
SS2200 Controller	115 VAC	SS2200

# Spray Systems

Spray systems are used to lubricate large gears and pinion sets such as those found on ball mills, rod mills, kilns, etc. Each system includes an air operated pumping station (items 1 through 10 below), a measuring valve panel (item 11), a spray nozzle lance (item 12) and electrical controls (item 13).

Gear face widths of 2" to 42" can be lubricated by nozzles with appropriate spacing on the spray lance. Since gear spray systems operate intermittently, they can be thought of as film maintaining devices. The electrical controls provide broad cycling flexibility as well as fault monitoring and afterblow to purge the nozzles.

Thirteen items are required to complete a Dualine spray system. Items 1 through 10 are listed below. The Spray Lance (item 12) should be selected based on gear face width. The Valve Panel (item 11) should be selected based on the number of spray nozzles required. The SC400 controller is described in detail on pages 20-21.

## Typical Layout

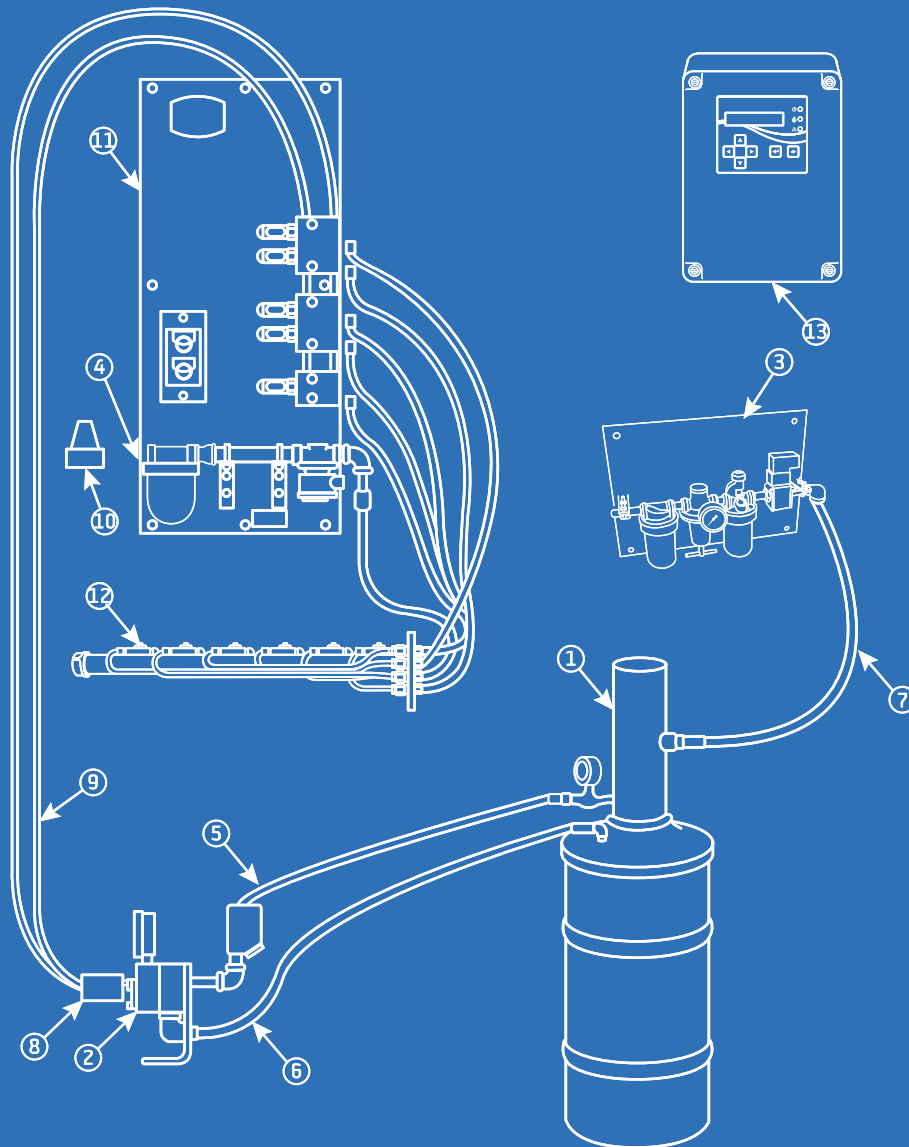

Item	Description	Part #
1	120 lb Air-operated barrel pump	9120
2	Reversing valve	DR4-60A
3	Air control panel	LD-7767C-A1
4	Air pressure switch (not shown)	U-623
5	Lube supply hose kit (72")	200275
6	Relief hose kit (72")	200277
7	Air hose kit (72")	200325
8	2 way line checks	U-1929D
9	Supply line pipe or hose to panel	BY USER
10	Air regulator	F119-4G
11	Valve panel	LD-12361-VX
12	Spray lance	LD-9327-XXXXX
13	Timer control	SC400

The 9120 pump for 120 pound drums is recommended where solvent cut-back lubricants are used. This will intentionally require frequent drum changes to prevent drying and hardening of the lubricant. The 9400 pump for 400 pound drums is available if drying and hardening of the lubricant is not a problem.

A U-623 pressure switch (item 4) is used to give warning of low pressure and is an optional feature.

All Central Pumping Stations are for 120 Volts, 60 Cycle, but other voltages and frequencies are available.

The U-1929D two way checks are needed only if the lubricants have fluid characteristics.

## How to Order

### Spray Panels

Spray Nozzles	Part #
1	LD-12361-V1
2	LD-12361-V2
3	LD-12361-V3
4	LD-12361-V4
5	LD-12361-V5
6	LD-12361-V6
7	LD-12361-V7

### Spray Lance

Gear Face Width	Guard Width	Spray Nozzles	Part #
2"	4.5"	1	LD-9327-1020S
3"	5.5"	1	LD-9327-1030S
4"	6.5"	1	LD-9327-1040S
5"	7.5"	1	LD-9327-1050S
6"	8.5"	1	LD-9327-1060S
7"	9.5"	2	LD-9327-2070S
8"	10.5"	2	LD-9327-2080S
9"	11.5"	2	LD-9327-2090S
10"	12.5"	2	LD-9327-2100S
11"	13.5"	2	LD-9327-2110S
12"	14.5"	3	LD-9327-3120S
13"	15.5"	3	LD-9327-3130S
14"	16.5"	3	LD-9327-3140S
15"	17.5"	3	LD-9327-3150S
16"	18.5"	3	LD-9327-3160S
17"	19.5"	4	LD-9327-4170S
18"	20.5"	4	LD-9327-4180S
19"	21.5"	4	LD-9327-4190S
20"	22.5"	4	LD-9327-4200S
21"	23.5"	4	LD-9327-4210S
22"	24.5"	5	LD-9327-5220S
23"	25.5"	5	LD-9327-5230S
24"	26.6"	5	LD-9327-5240S
25"	27.5"	5	LD-9327-5250S
26"	28.5"	6	LD-9327-6260S
27"	29.5"	6	LD-9327-6270S
28"	30.5"	6	LD-9327-6280S
29"	31.5"	6	LD-9327-6290S

Gear Face Width	Guard Width	Spray Nozzles	Part #
30"	32.5"	6	LD-9327-6300S
31"	33.5"	6	LD-9327-6310S
32"	34.5"	7	LD-9327-7320S
33"	35.5"	7	LD-9327-7330S
34"	36.5"	7	LD-9327-7340S
35"	37.5"	7	LD-9327-7350S
36"	38.5"	7	LD-9327-7360S
37"	39.5"	7	LD-9327-7370S
38"	40.5"	8	LD-9327-8380S
39"	41.5"	8	LD-9327-8390S
40"	42.5"	8	LD-9327-8400S
41"	43.5"	8	LD-9327-8410S
42"	44.5"	8	LD-9327-8420S

When ordering Spray Panels, specify by name, number of spray nozzles and part number, e.g. Spray Panel, 3 Spray Nozzles, **Part #LD-12361-V3**.

When ordering Spray Lance, specify by name, gear face width and part number, e.g. Spray Lance, 8" Gear Face Width, **Part #LD-9327-2080S**.

See Operators Manual #DL3100 for additional information.

## Innovators of engineered lubrication technology **since 1923**

Bijur Delimon International has ISO 9001:2000 and ISO 14001:2000 quality certified manufacturing facilities around the world, so your centralized lubrication system meets the highest industry quality standards. It's all part of our commitment to quality and customer service.



**BIJUR DELIMON NORTH AMERICA**  
2685 Airport Road  
Kinston, NC 28504

(252) 527 6001 **LOCAL**  
(800) 227 1063 **TOLL-FREE**  
(252) 527 3533 **FAX**

[WWW.BIJURDELIMON.COM](http://WWW.BIJURDELIMON.COM)

**DL29 • R11** 09/13